

TLV®

PowerTrap®

MODEL GT5C CAST IRON

COMPACT MECHANICAL PUMP WITH STEAM TRAP EFFECTIVE FOR ELIMINATING STALL

Features

Pump/trap with built-in steam trap, a linear inlet/outlet, low filling head, and simple piping installation for small heat exchangers and steam/air heaters often operating under stall conditions.

1. Handles high-temperature condensate without cavitation.
2. No electric power or additional level controls required, hence INTRINSICALLY SAFE.
3. Extremely low 155 mm filling head.
4. Simplified piping (no exhaust pipe required) and linear inlet/outlet greatly reduce installation time.
5. Easy, inline access to internal parts simplifies cleaning and reduces maintenance costs.
6. High-quality stainless steel internals and hardened working surfaces ensure reliability.
7. Compact design permits installation in a limited space.



Specifications

Model		GT5C	
Connection	Pumped Medium Inlet & Outlet	Screwed	Flanged*
	Motive Medium & Pump Exhaust	Screwed	Screwed
Size	Pumped Medium Inlet / Outlet	1" / 1"	DN 25 / 25
	Motive Medium inlet		1/2"
	Pump Exhaust Outlet		3/8"
Maximum Operating Pressure (barg)	PMO	5	
Maximum Operating Temperature (°C)	TMO	185	
Motive Medium Pressure range (barg)		0.3 - 5	
Maximum Allowable Back Pressure		0.5 bar less than motive medium pressure used	
Volume of Each Discharge Cycle (ℓ)		Approximately 1.4	
Motive Medium		Saturated steam	
Pumped Medium		Steam condensate	

* Screwed-in Flange

1 bar = 0.1 MPa

PRESSURE SHELL DESIGN CONDITIONS (**NOT** OPERATING CONDITIONS):

Maximum Allowable Pressure (barg) PMA: 8

Maximum Allowable Temperature (°C) TMA: 200



To avoid abnormal operation, accidents or serious injury, DO NOT use this product outside of the specification range. Local regulations may restrict the use of this product to below the conditions quoted.

No.	Description	Material	DIN*	ASTM/AISI*	
①	Body	Cast Iron FC250	0.6025	A126 Cl.B	
②	Cover	Cast Iron FC250	0.6025	A126 Cl.B	
③	Cover Gasket	Fluorine Resin PTFE	PTFE	PTFE	
④	Float	Stainless Steel SUS316L	1.4404	AISI316L	
⑤	Snap-action Unit	Stainless Steel	—	—	
⑥	Intake-Exhaust Valve Unit	Valve	Stainless Steel SUS440C	1.4125	AISI440C
		Valve Seat	Stainless Steel SUS440C	1.4125	AISI440C
⑦	Trap Unit (with Outlet Check Valve)	Stainless Steel SUS420F	1.4028	AISI420F	
⑧	Air Vent Unit	Stainless Steel	—	—	
⑨	Inlet Check Valve	Stainless Steel SUS304	1.4301	AISI304	

* Equivalent materials

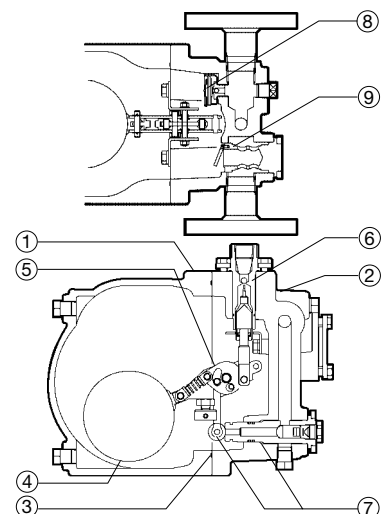

Pump Discharge Capacity

A Standard Pump Capacity (155 mm filling head, without Exhaust Pipe/Tube)

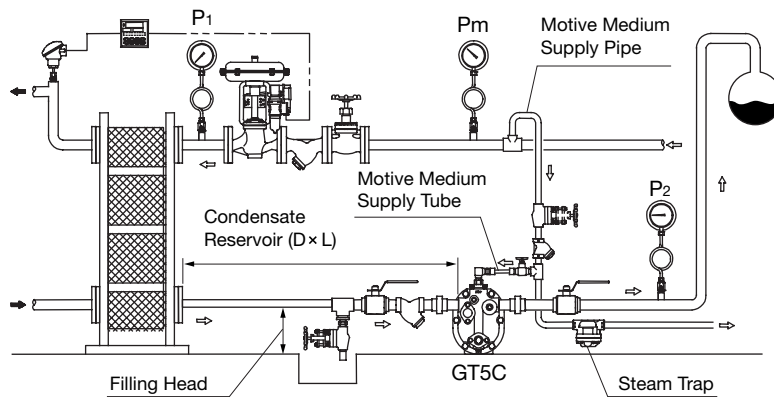
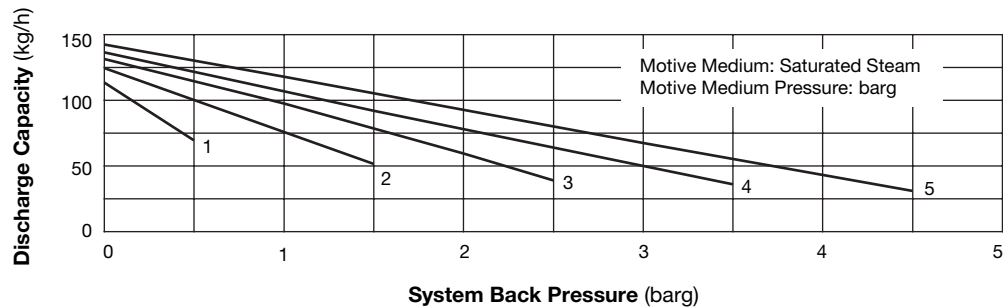

NOTE:

- Use the graph above to determine pump capacity based on the motive medium pressure (P_m) and the back pressure (P_2).
- Motive medium pressure (P_m) minus back pressure (P_2) must be greater than 0.5 bar.
- The motive medium supply pipe diameter should be at least 15 mm, and the motive medium tube and its fittings/valves should have an inner diameter of at least 8 mm.
- A 40 mesh or finer strainer must be installed at the motive medium and pumped medium inlets, and a steam trap installed on the motive medium supply pipe.
- For determining the length (L) and the size (D) of the pumped medium inlet pipe (condensate reservoir), refer to the "Size of Reservoir" table.
- It is possible to eliminate the exhaust pipe/tube in case there is vertical piping on the pumped medium inlet due to elevated position of equipment condensate outlet (as shown to the right). However the pump capacity is the standard pump capacity with 155 mm filling head.

Vertical Piping Diagram

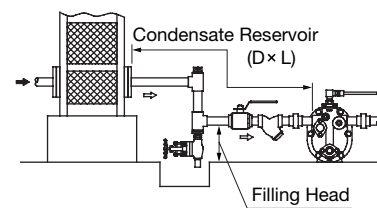

Pump Discharge Capacity (Continued)

B Increased Pump Capacity (300 mm filling head, with Exhaust Pipe/Tube)

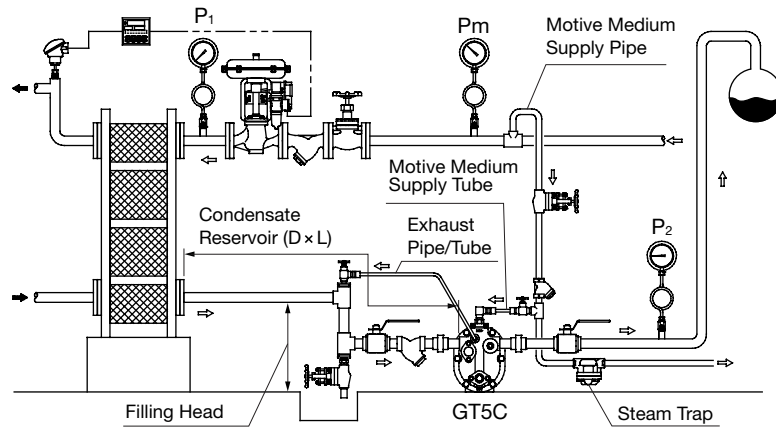
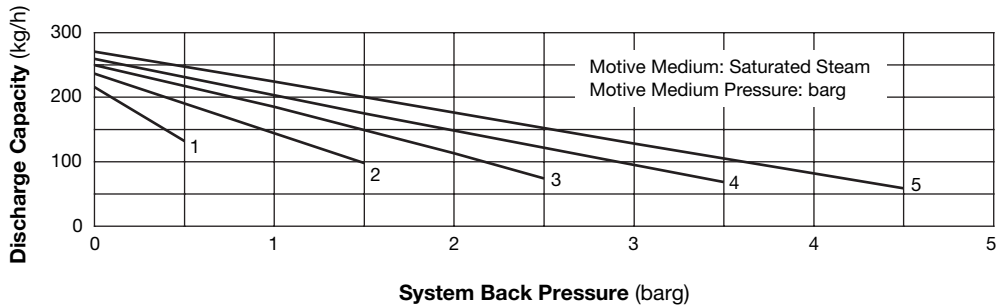

NOTE:

- Use the graph above to determine pump capacity based on the motive medium pressure (Pm) and the back pressure (P2), using the graph to find the correction factor if the filling head is other than 300 mm.
- Motive medium pressure (Pm) minus back pressure (P2) must be greater than 0.5 bar.
- The motive medium supply pipe diameter should be at least 15 mm, and the motive medium tube as well as the exhaust tube/pipe and its fittings/valves should have an inner diameter of at least 8 mm.
- A 40 mesh or finer strainer must be installed at the motive medium and pumped medium inlets, and a steam trap installed on the motive medium supply pipe.
- For determining the length (L) and the size (D) of the pumped medium inlet pipe (condensate reservoir), refer to the "Size of Reservoir" table.
- When installing the exhaust pipe/tube, the fitting tube delivered with the product must be installed.

Correction Factors

(for filling heads other than 300 mm)

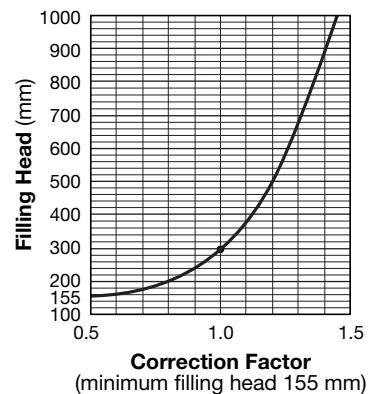

Size of Reservoir

The reservoir must have capacity sufficient to store the condensate produced during the **PowerTrap** operation and discharge.

Size of Reservoir

Amount of Condensate (kg/h)	Reservoir Diameter (mm) and Length (m)				
	25	32	40	50	80
50	0.6m				
100	1.2	0.6	0.4		
150	1.8	1.0	0.6	0.4	
200	2.4	1.3	0.8	0.5	
300		2.0	1.2	0.7	
400		2.6	1.5	1.0	
500			2.0	1.2	0.5

Reservoir length can be reduced by 50% when the motive medium pressure (Pm) divided by back pressure (P2) equals 2 or greater (when $Pm \div P2 \geq 2$).

Dimensions

Units: mm

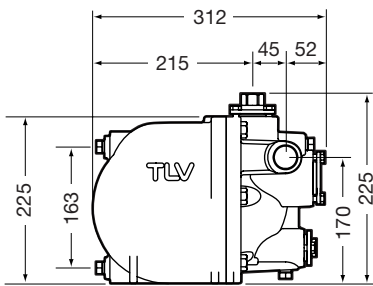

Note: All plug holes are 3/8" BSP

● **Screwed***

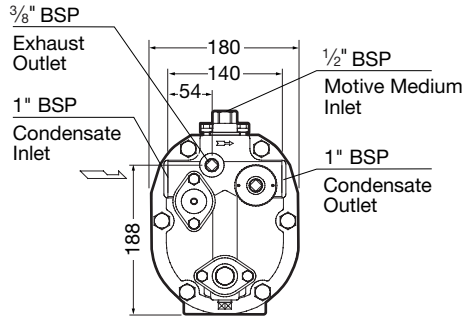

Weight (kg): 20
* BSP DIN 2999, other standards available

● **Flanged****

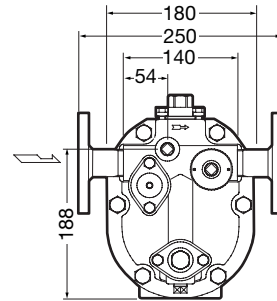

Weight (kg): 23
** DIN 2501 PN 16, other standards available but length and weight may vary

Steam Trap Discharge Capacity

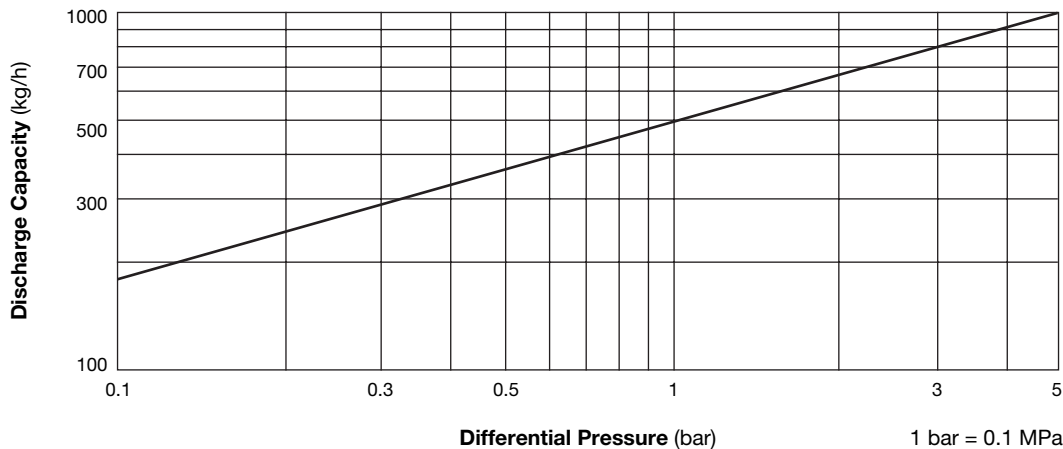

1. Capacity of GT5C as a steam trap (Inlet Pressure > Outlet Pressure). Instantaneous condensate loads above the rated trap capacity will cause the pump to cycle and therefore reduce the discharge capacity.
2. Capacities are based on continuous discharge of condensate 6 °C below saturated steam temperature.
3. Differential pressure is the difference between inlet and outlet pressure of the trap.
4. Recommended safety factor: at least 1.5

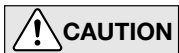

CAUTION DO NOT use this product under conditions that exceed maximum differential pressure, as condensate backup will occur!

ISO 9001/ISO 14001

